

Items Supplied >

- 1 - Sissy Bar w/ Pad & Interchangeable Chrome Insert
- 2 - Mount Brackets (Left/Right)
- 2 - 5/16"-18 x 1-1/2" Buttonhead Bolts
- 2 - 5/16"-18 x 1-3/4" Buttonhead Bolts
- 4 - M8 x 20mm Buttonhead Bolts

Application(s) >

HARLEY SPORTSTER 2004-2019

Instruction Manual >

602-1253 / 602-1303

Page 1 of 2

Read all instructions carefully before installing your new Cobra® product!

1. If the motorcycle is equipped with rear reflectors on the fender rail cover than they must be removed along with any remaining adhesive left on the motorcycle. Save the reflectors for reuse.
2. Remove the bolts, washers, locknuts and clipnut from the right side fender rail. Save the locknuts and clipnut for reuse.
3. Remove the chrome fender rail cover with the turn signal attached (for wire slack, you may need to disconnect the turn signal wires from the retaining clip under the fender).
4. Install right sissy bar mounting bracket between the fender rail and fender (part # facing inward).
NOTE: Be careful not to scratch the fender paint when positioning the sissy bar mounting bracket. Make sure the turnsignal wiring passes through the cutout (slot). Align all the holes and reinstall chrome fender rail cover into place. See Figure 1.
5. Insert the supplied 5/16"-18 x 1-1/2" buttonhead bolt through the rear hole of the chrome cover/fender rail, sissy bar mount bracket, and fender; secure with the stock clipnut. Insert the supplied 5/16"-18 x 1-3/4" buttonhead bolt through the front hole of the chrome cover/fender rail, sissy bar mount bracket, and fender; secure with the stock locknut. Secure the turnsignal stud with the stock locknut. **DO NOT TIGHTEN AT THIS TIME.**
6. Repeat Steps 2-5 on left side.
7. Install the sissy bar between the brackets using the four (4) supplied M8 x 20mm buttonhead bolts.
8. Align sissy bar and torque all bolts to their appropriate values.
9. Reinstall turn signal wiring into retaining clip. Attach the rear reflectors onto the chrome covers.

ALTERNATE BACKREST INSERTS AVAILABLE AT COBRAUSA.COM

* *Cobra® recommends you always wear a helmet while riding. Please never operate your motorcycle while under the influence of alcohol and/or drugs. Enjoy the new look of your motorcycle and please ride safely.*

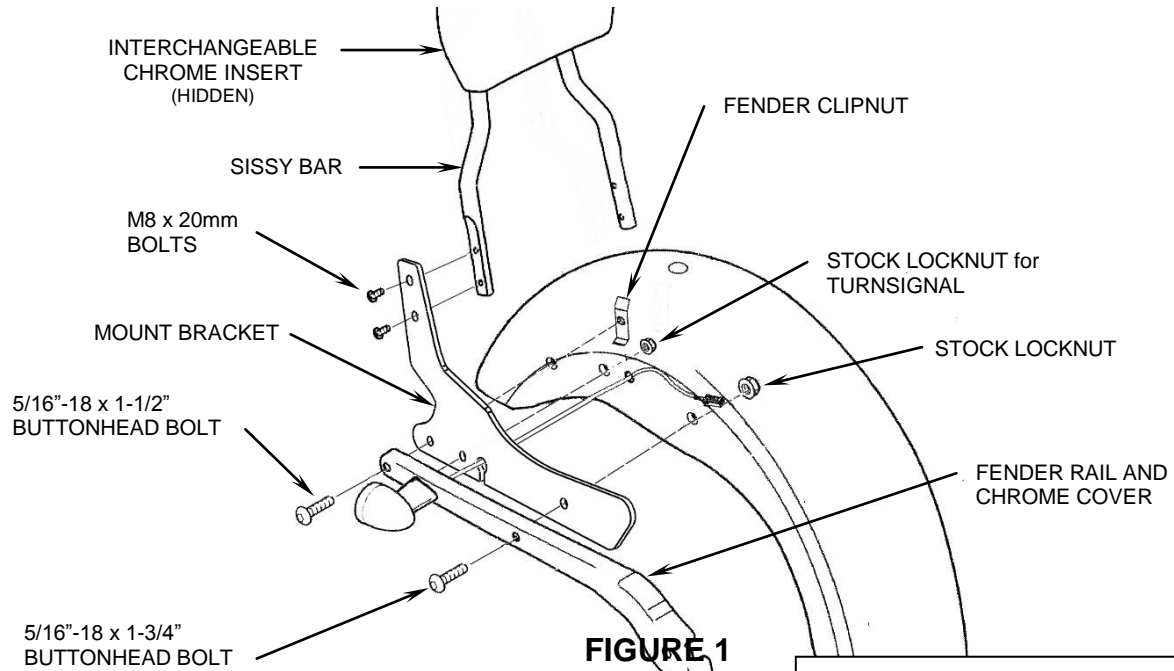

FIGURE 1
(RIGHT SIDE SHOWN)

PICTURE MAY VARY FROM APPLICATION
(FENDER DOES NOT SEPARATE FROM FENDER RAIL)